

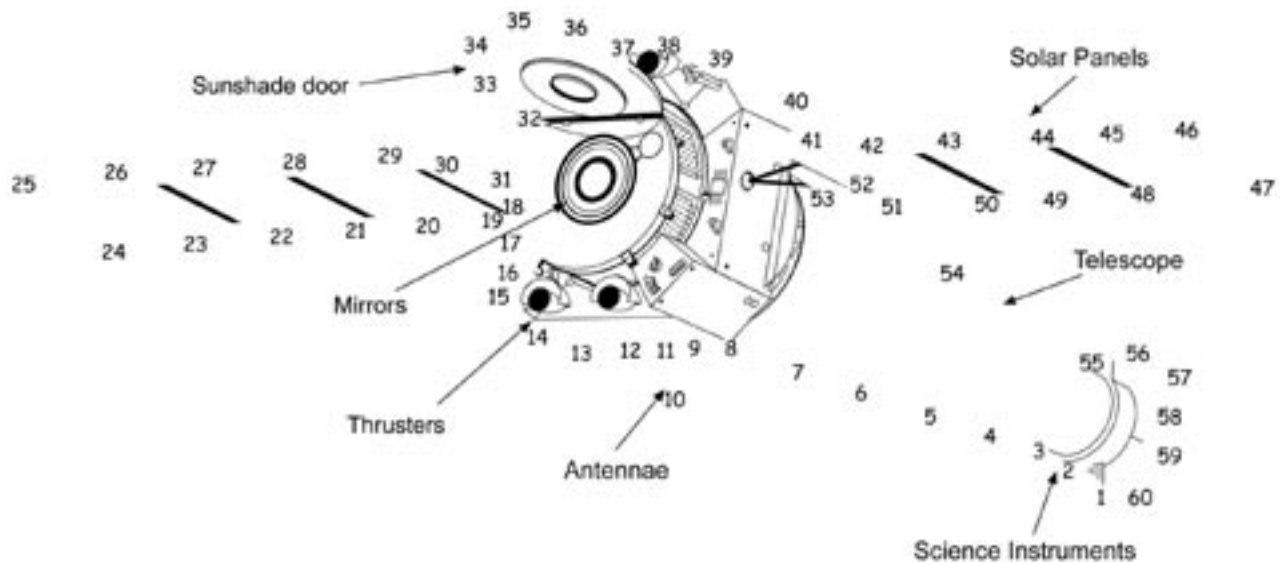

CHANDRA X-RAY OBSERVATORY

The Spacecraft



The Chandra X-ray Observatory is one of NASA's Great Observatories, along with the Hubble Space Telescope, the Spitzer Space Telescope, and the Compton Gamma Ray Observatory (now de-orbited).

Chandra detects X-ray light from very hot (millions of degrees) places in the Universe, such as exploding stars, galaxy clusters and matter swirling into black holes.

Chandra was taken into space on July 23, 1999, aboard the Space Shuttle Columbia (mission STS-93).



CHANDRA X-RAY OBSERVATORY

Astronauts: STS-93 Crew



A picture taken in orbit during the STS-93 mission to release the Chandra X-ray Observatory.
Front (left to right): Collins, Tognini
Rear: Hawley, Ashby, Coleman



A crew of five astronauts released the Chandra X-ray Observatory into space.

Commander: Col. Eileen Collins. Collins was the first woman to command a NASA space mission. The commander is the captain of the ship. She is responsible for the vehicle, crew, mission success, and safety of flight. She also flies the shuttle during approach and landing.

Pilot: Cmdr. Jeff Ashby. The pilot is trained to do all the same jobs as the Commander. He helps to control and operate the shuttle. Neither he nor the commander can do spacewalks in case there should be an emergency.

Mission Specialists: Dr. Steven Hawley, Dr. Cady Coleman, Col. Michel Tognini. Mission specialists are trained to conduct the science experiments on their mission. They also perform space walks and operate the remote manipulator system (RMS). Coleman used the RMS to release Chandra into space.



CHANDRA X-RAY OBSERVATORY

Chandra Word Search



Chandra
Space
Xrays
Mirrors
NASA

Universe
Wavelength
Star
Galaxy
Blackhole

Find the words hidden in this puzzle. Words may be hidden horizontally, vertically, forward, or backward.

CHANDRA X-RAY OBSERVATORY

The Electromagnetic Spectrum

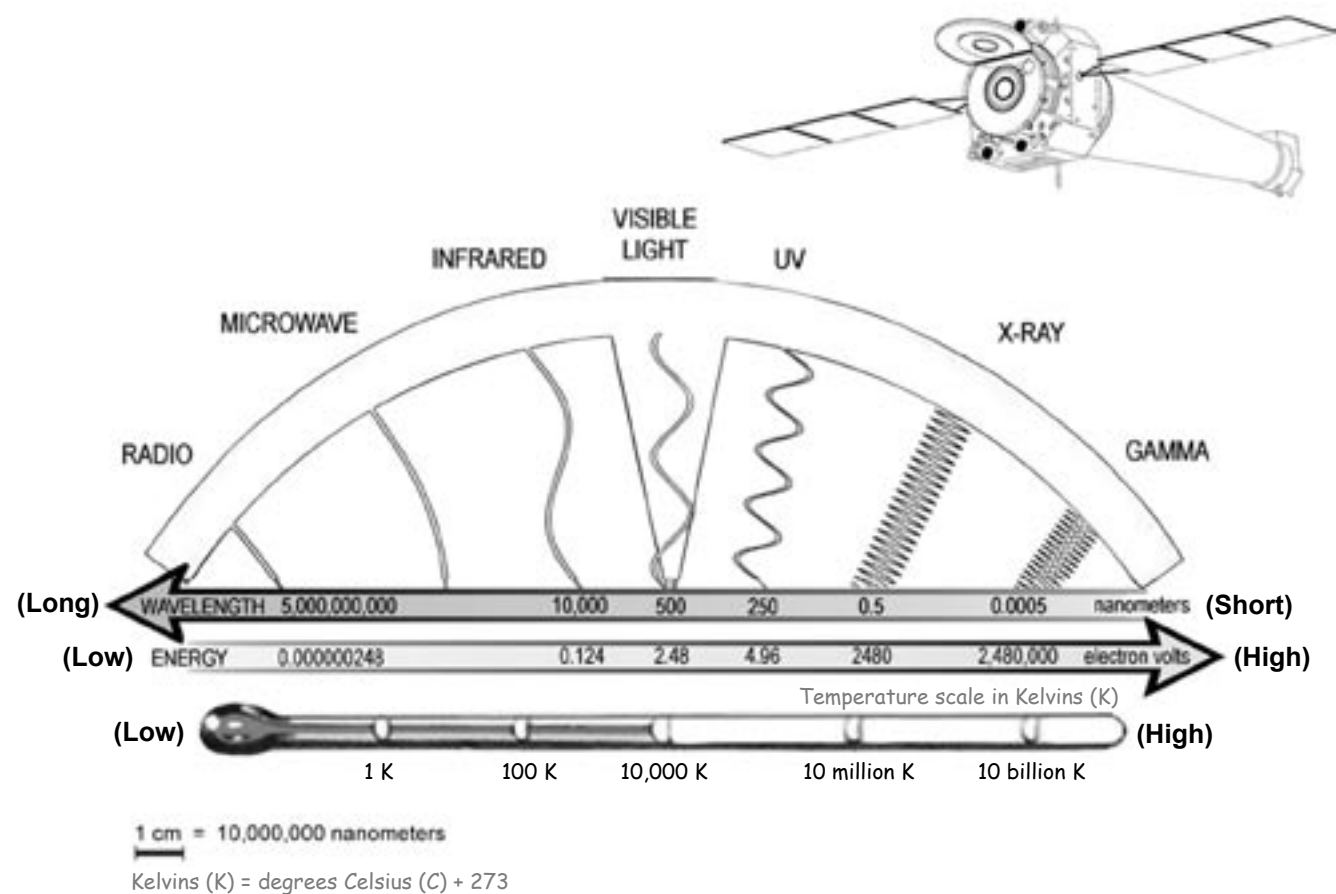

Light comes in many energies called the electromagnetic spectrum. The only light our eyes see is visible light. Sunshine is mostly visible light.

Objects in the sky also shine in kinds of light that we can't see, such as radio, infrared or X-ray. If these objects are very, very hot (millions of degrees), or very energetic, they can shine in X-rays. The Chandra X-ray Observatory detects the objects that give off X-rays. You can color the electromagnetic spectrum using colors to represent low to high energies, wavelengths, or temperatures.

CHANDRA X-RAY OBSERVATORY

Chandra Mirrors

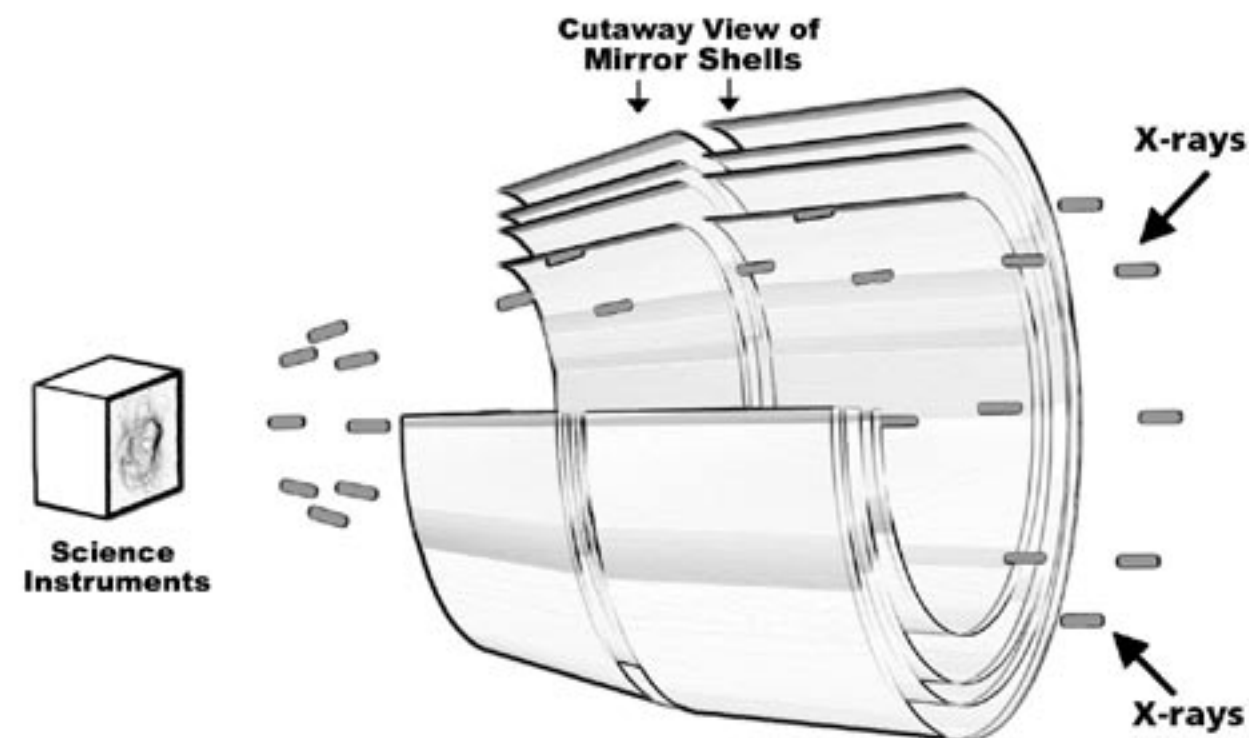

The Chandra mirrors are very unusual. They are made up of 2 sets of 4 hollow glass cylinders (also called shells). The shells look like drinking glasses with the ends cut off. They were carefully polished on the inside to reflect X-rays. The X-rays skip off the insides of the cylinders like stones skipping across a pond and come to a focus at the science instruments. The mirror shells are coated with a rare metal, iridium, to make them reflect X-rays better. This gives the shells a silvery, shiny look.

The Chandra images are not made by exposing photographic film, but by a process which is similar to how a digital camera or camcorder works. Chandra's mirrors focus the incoming X-rays from a cosmic source onto one of the instruments (the High Resolution Camera or the Advanced CCD Imaging Spectrometer). The instruments record the number of X-rays (photons) hitting a particular spot on the instrument. The data are stored on tape recorders for later transmission to Earth.



CHANDRA X-RAY OBSERVATORY

Data Path

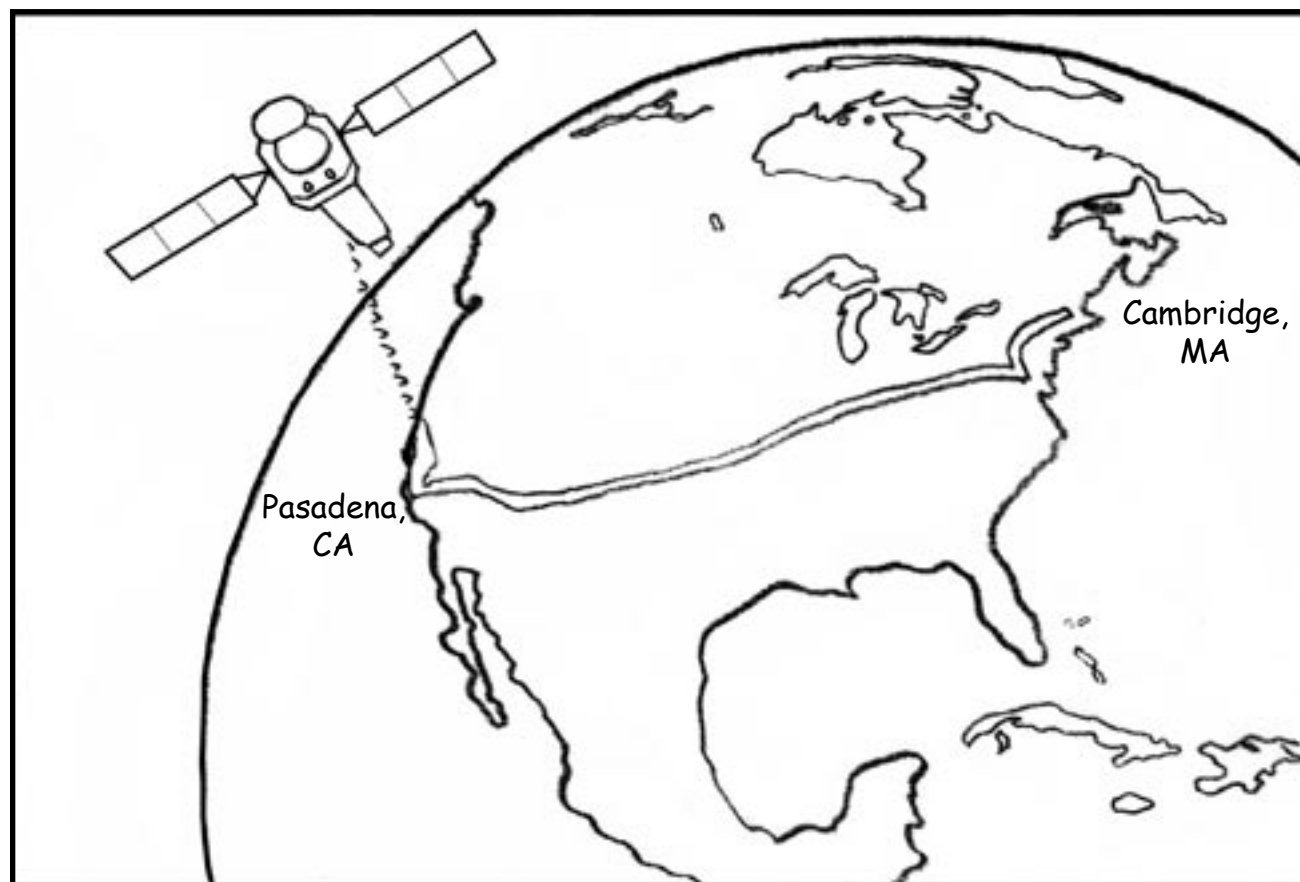

Every 8 hours or so, Chandra makes contact with one of the three stations in NASA's Deep Space Network (in California, Spain, and Australia). Chandra radios the data it has stored down to Earth. The data are sent through high speed land lines to the Chandra X-ray Center in Cambridge, Massachusetts, where they are processed and distributed to scientists all over the world.



CHANDRA X-RAY OBSERVATORY

Chandra Crossword

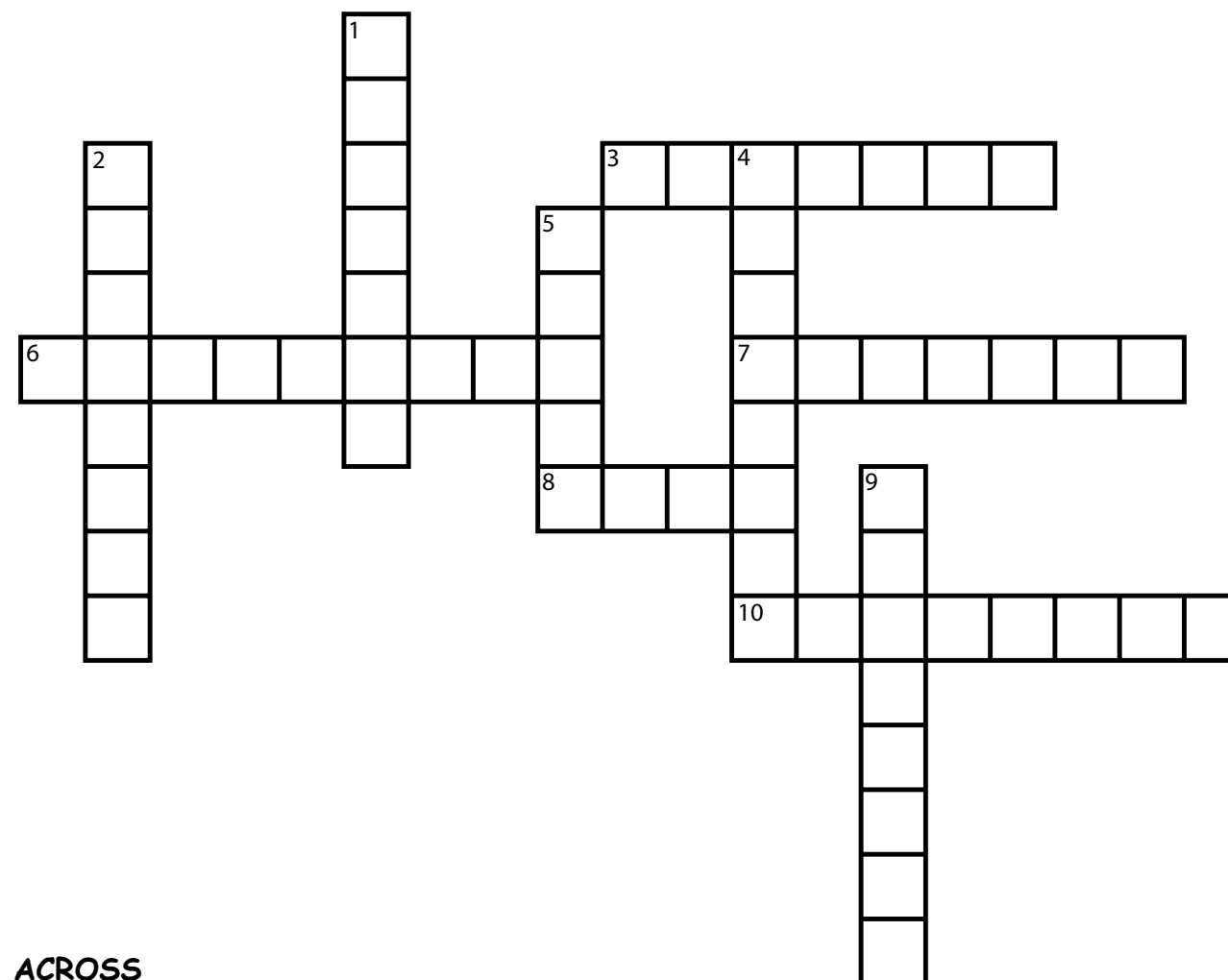

ACROSS

- Sunshine is mostly _____ light.
- Massive star that uses up all of its fuel and explodes.
- 3c295 is an example of a galaxy _____.
- Eta Carinae is a very unusual, unstable _____.
- Supermassive black holes have a mass of many _____ of stars.

DOWN

- Eileen _____ was the first woman to command a NASA space mission.
- Space Shuttle that Chandra was launched on.
- Light comes in many energies called the electromagnetic _____.
- Chandra detects objects that give off _____.
- Our galaxy, the _____.



CHANDRA X-RAY OBSERVATORY

False Color

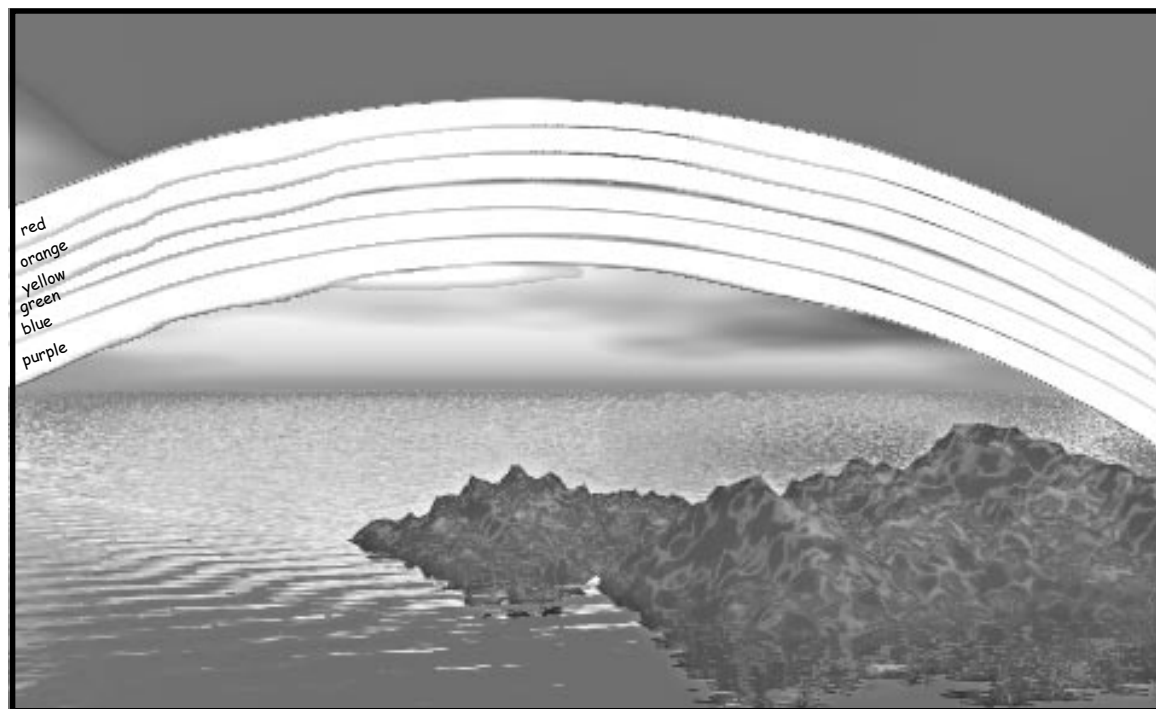

The colors we see in the world around us are the result of the way that the human eye and brain perceive different wavelengths of light in the visible part of the electromagnetic spectrum. X-rays, and other wavelengths such as radio, infra-red, ultra-violet and gamma, cannot be seen with the human eye, and thus do not have any "color". To see the invisible wavelengths, we need detectors that are especially designed to see those other wavelengths, such as the instruments on Chandra.

Sometimes images taken by telescopes that look at the "invisible" wavelengths are called "false color images". That is because the colors we use in them are not "real" but are chosen to bring out important details. For example, the colors can be associated with the intensity or brightness of the radiation from different regions of the image, or in some cases with the temperature or the energy of the emissions.

The color choice is usually a matter of personal taste, and is used as a kind of code. We can use colors or even shades of black and white to indicate brightness, intensity, temperature or energy on a scale from high to low. In this way we can show the contrasts between different regions in the X-ray source, and highlight features that give us clues to its structure.



CHANDRA X-RAY OBSERVATORY

False Color

In the black and white Chandra X-ray image below, the darker shades represent the most intense X-ray emissions, the lighter shades of grey represent the areas of less intense emission, and the white areas represent the areas of little to no emission. On the back cover you see a version of the same Chandra image with a different "color code". There, the white and yellow colors represent the areas of highest X-ray intensity, the orange to red areas represent the areas of lower intensity, and the black represents little or no emission.

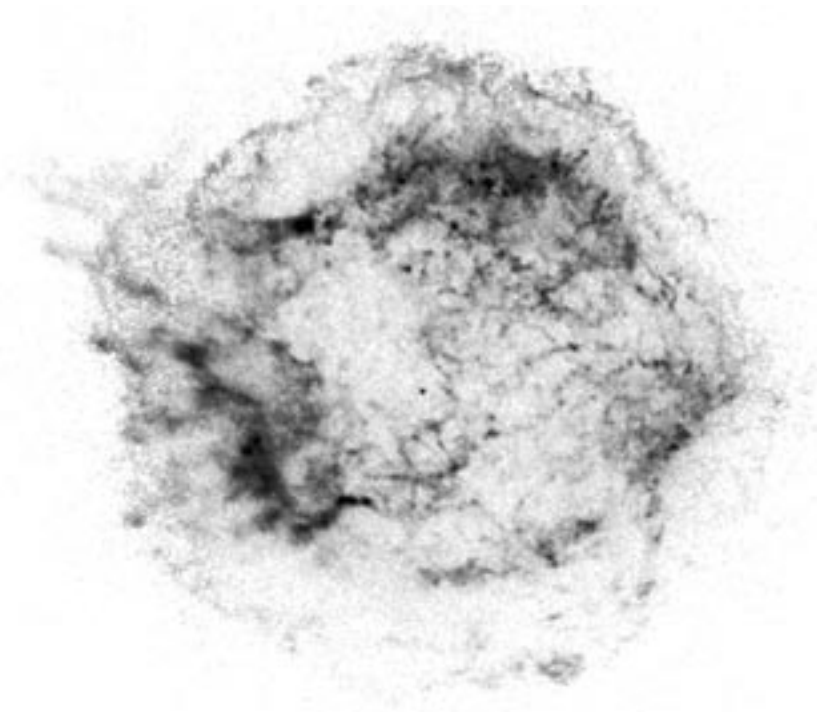

On the back cover we show one way of coloring the Chandra images which you will find in this book. In the color code that we show, the white and yellow colors represent the areas of the highest X-ray intensity or brightness, and the orange to red to violet colors represent less intensity or brightness. You can choose whichever colors you want to represent the different areas of X-ray intensity. Use the information on the back cover to see where the high, medium and low areas of brightness are in each image.



CHANDRA X-RAY OBSERVATORY

Supernovas: Cassiopeia A

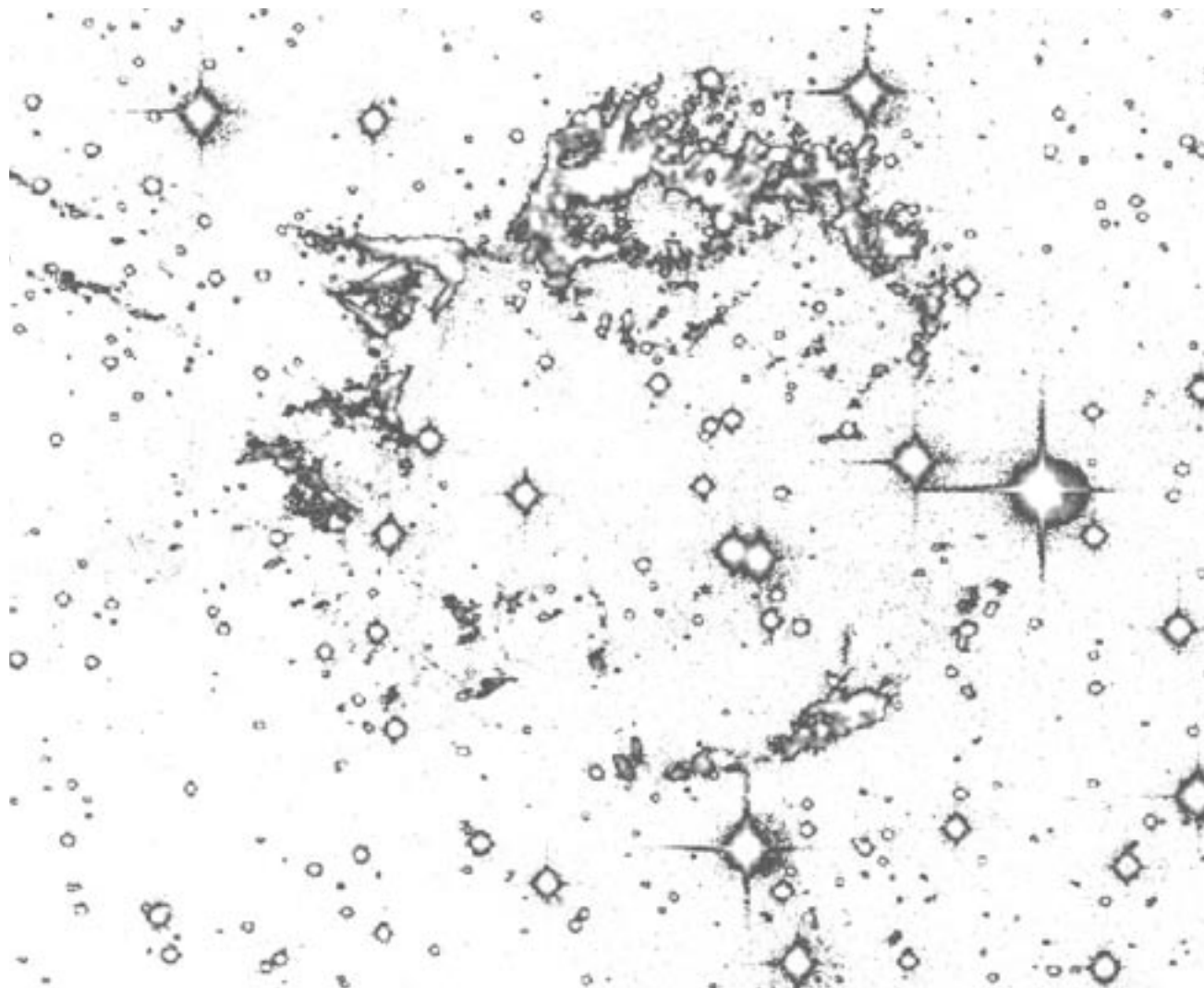

Optical Image

Cassiopeia A (Cas A) was a massive star that used up all of its fuel and exploded. The scattered, glowing remains from the explosion are called a supernova remnant. The explosion was noticed on Earth about 300 years ago. This is a picture of the Cas A supernova remnant taken in optical light by the MDM Observatory. In this optical picture of Cas A, a few wisps of the outer edges of the cloud of expanding gas can be seen. Supernova remnants continue to glow in optical light but many of them radiate most strongly in other wavelengths.



CHANDRA X-RAY OBSERVATORY

Supernovas: Cassiopeia A

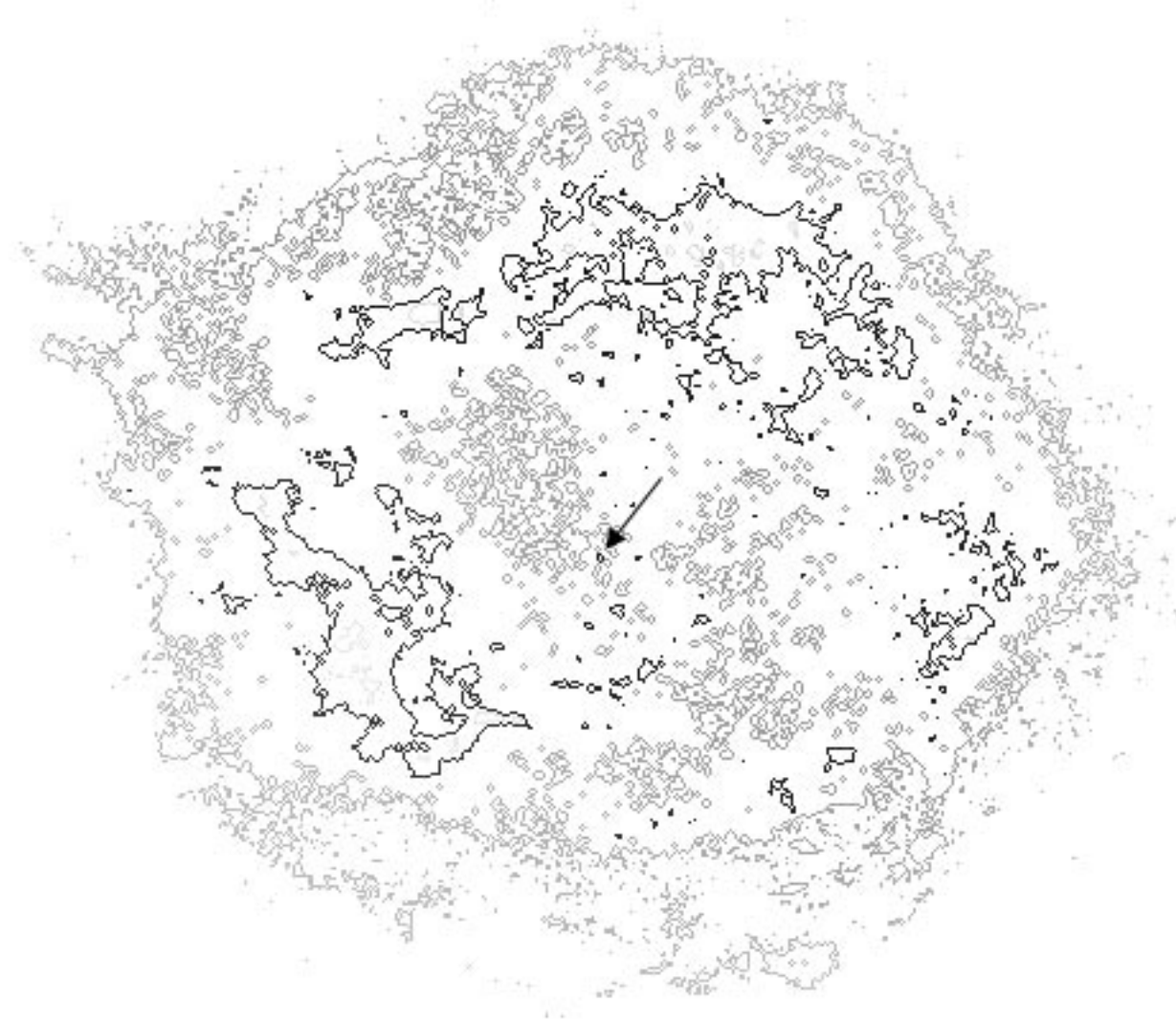

X-ray Image

Cas A's explosion produced a cloud of very hot (50 million degree) gas that is still expanding. Chandra's very sharp focus also allowed scientists to identify a dot in the center (see arrow) that may be a hot, superdense neutron star formed as a result of the star's collapse and explosion. The gas cloud radiates very strongly in X-rays. That is why X-ray telescopes like Chandra are very useful for studying supernova remnants. This image of Cas A was Chandra's official "First Light" image. It was taken about 1 week after the doors and covers over Chandra's mirrors and detectors were opened.



CHANDRA X-RAY OBSERVATORY

Spacey Maze

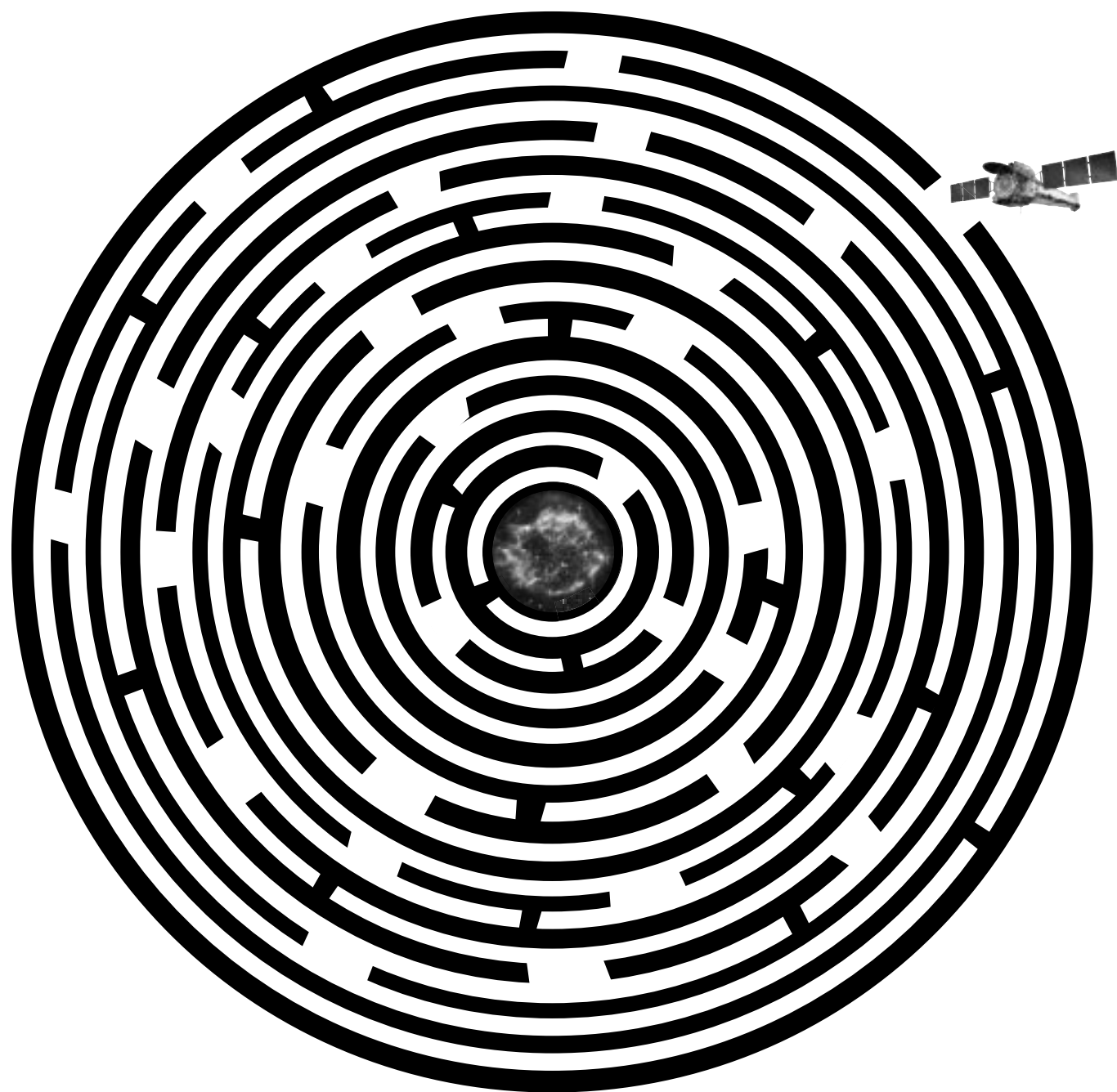

Help Chandra find the supernova.



CHANDRA X-RAY OBSERVATORY

Supernovas: E0102



E0102 is a thousand-year old supernova remnant in the Small Magellanic Cloud, a satellite galaxy of our Milky Way which is 190,000 light years from Earth. The enormous hot cloud of stellar debris stretches across 40 light years of space (a light year is the distance light travels in one year: 10 trillion kilometers or 6.2 trillion miles). The multi-million degree source resembles a flaming cosmic wheel with puzzling spoke-like structures in its interior.



CHANDRA X-RAY OBSERVATORY

Supernovas: Crab Nebula

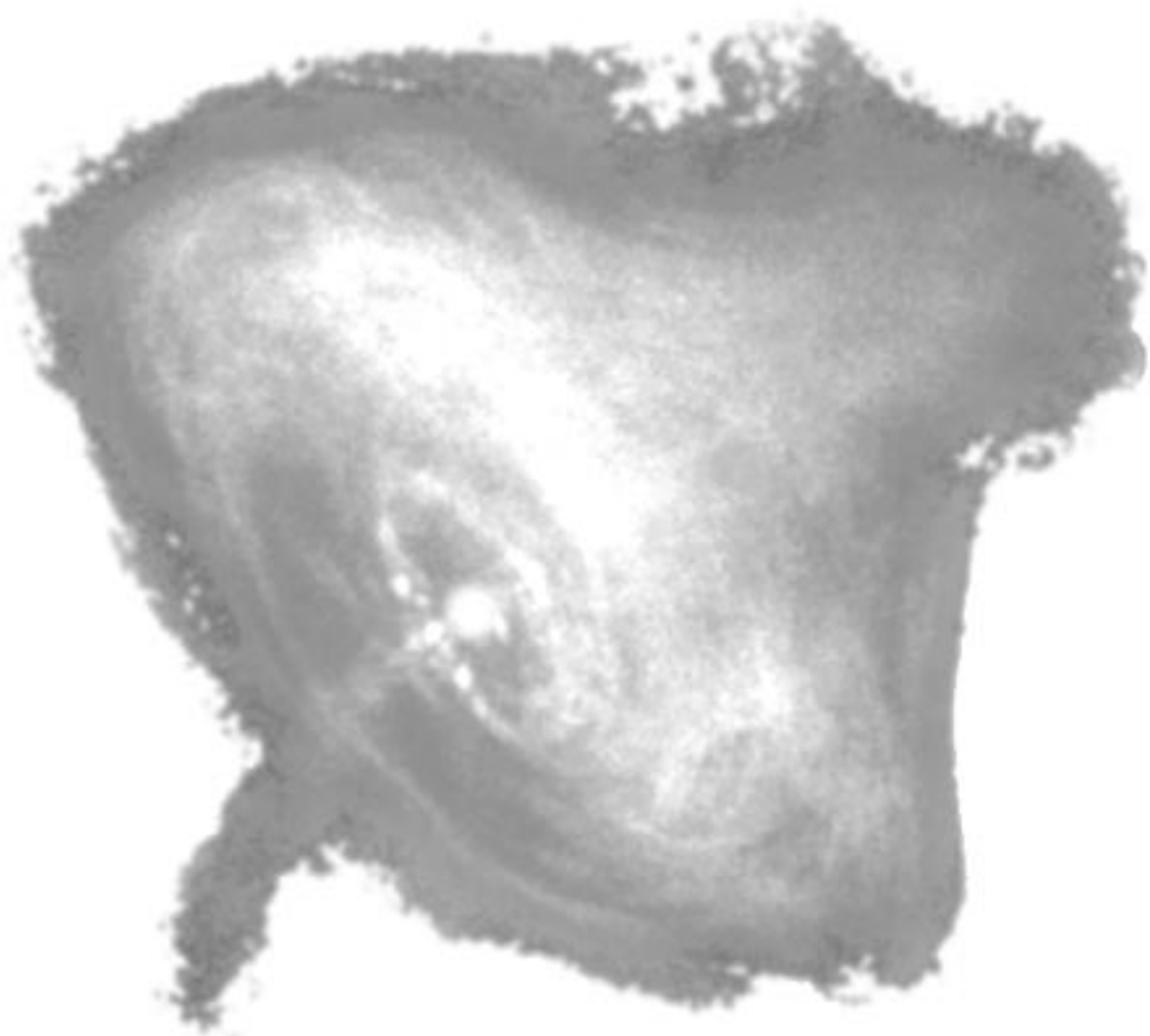

The Crab Nebula is the remnant of a supernova explosion that was so powerful that it was seen on Earth by Chinese and Japanese astronomers in 1054 AD, long before telescopes were invented. Chandra is able to image the very heart of the remnant where a neutron star, only 10 miles across, but as massive as our sun, is spinning around 30 times a second. The Chandra image shows for the first time the inner rings and jets of high energy particles that radiate X-rays as they are accelerated around magnetic field lines by the spinning neutron star. The Crab Nebula is located in the constellation Taurus and is still a bright source of radiation in all wavelengths.



CHANDRA X-RAY OBSERVATORY

Supernova Word Search



Explosion
Elements
Crab
Nebula
Xray

Supernova
Remnant
Massive
Star

Find the words hidden in this puzzle. Words may be hidden horizontally, vertically, forward, or backward.



CHANDRA X-RAY OBSERVATORY

Black Holes

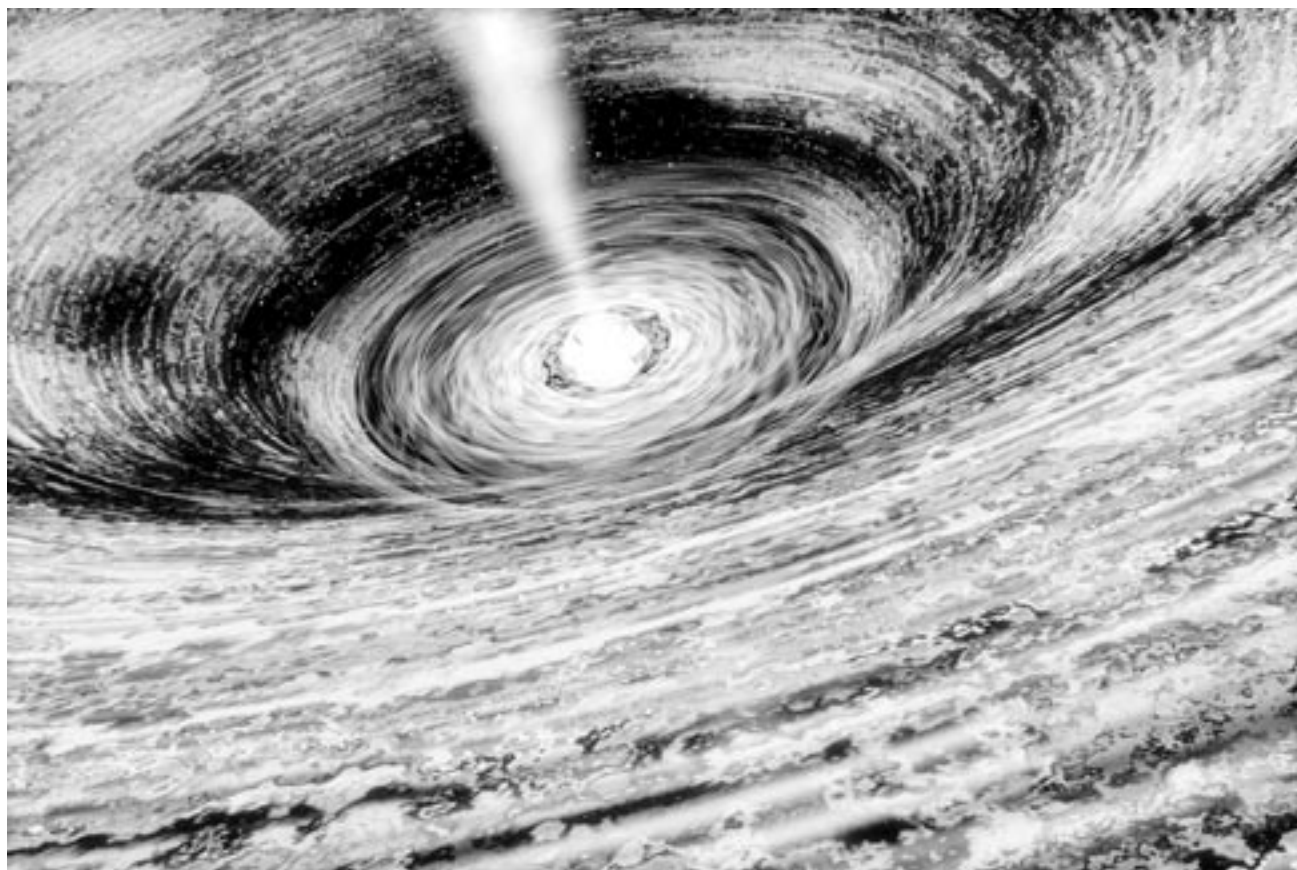

Black holes come in many sizes from small to supermassive. Astronomers can't see a black hole directly. The only way to find one is by observing the energy released by matter that is falling toward the black hole. X-rays are usually emitted by this process so astronomers are using Chandra to find and confirm suspected black hole locations. Supermassive black holes, with the mass of many millions of stars, are thought to lie at the center of most large galaxies.



CHANDRA X-RAY OBSERVATORY

Black Holes: Centaurus A

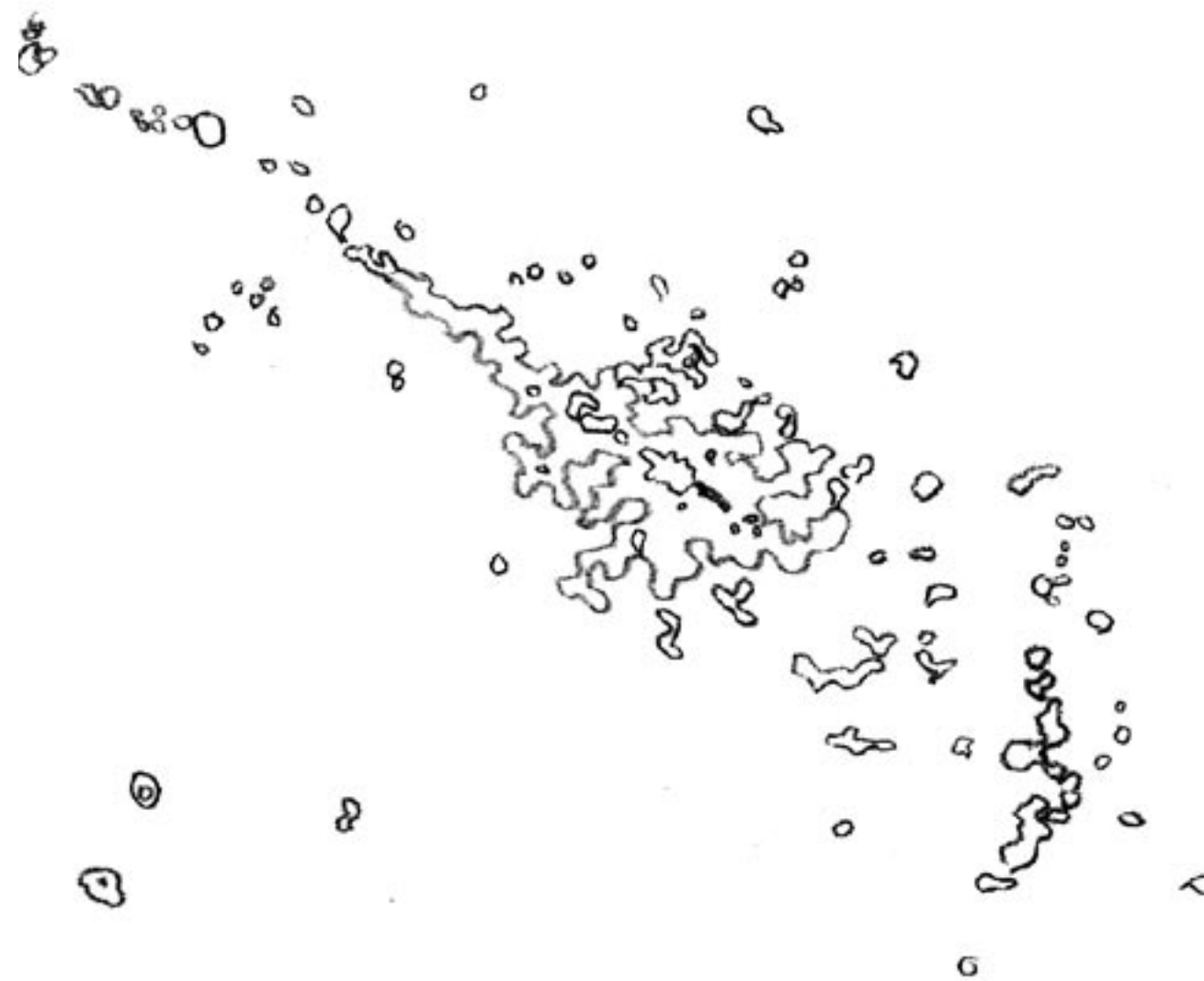

At a distance of 11 million light years, Centaurus A is the nearest example of a type of galaxy called an "active galaxy". In optical light we see a large, elliptically shaped galaxy. Both radio and X-ray images show a jet of high energy particles blowing out from the center. Chandra was able to image the knots and clumps of matter in this jet and to show its traces extending out to tens of thousands of light years from the nucleus. The X-radiation from the bright source in the center is associated with matter swirling into a supermassive black hole.



CHANDRA X-RAY OBSERVATORY

Black Holes: Centaurus A

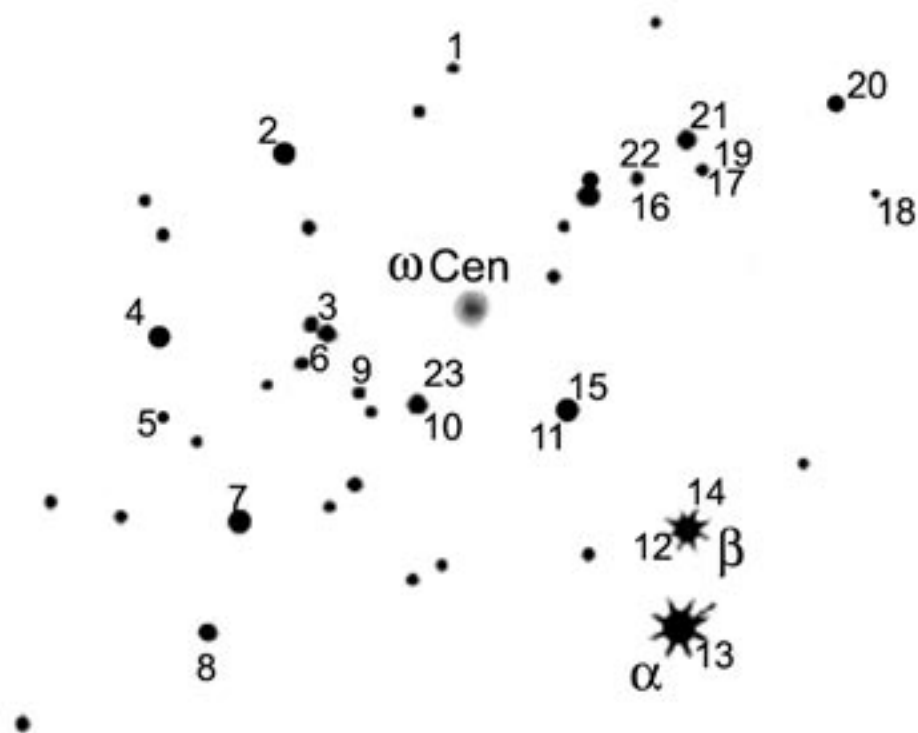

Centaurus A is in the constellation Centaurus. The constellation is named after a mythical Greek creature that is half human, half horse. Follow the numbers to see the shape of the constellation.



(AURA/NOAO/NSF)

This optical image shows that Centaurus A is an elliptical galaxy with huge dust lanes across the middle of the galaxy. This has led astronomers to speculate that Cen A was the site of a merger between a small spiral galaxy and a large elliptical galaxy several hundred million years ago. The optical radiation is mostly from stars.



CHANDRA X-RAY OBSERVATORY

Black Holes: NGC 6240

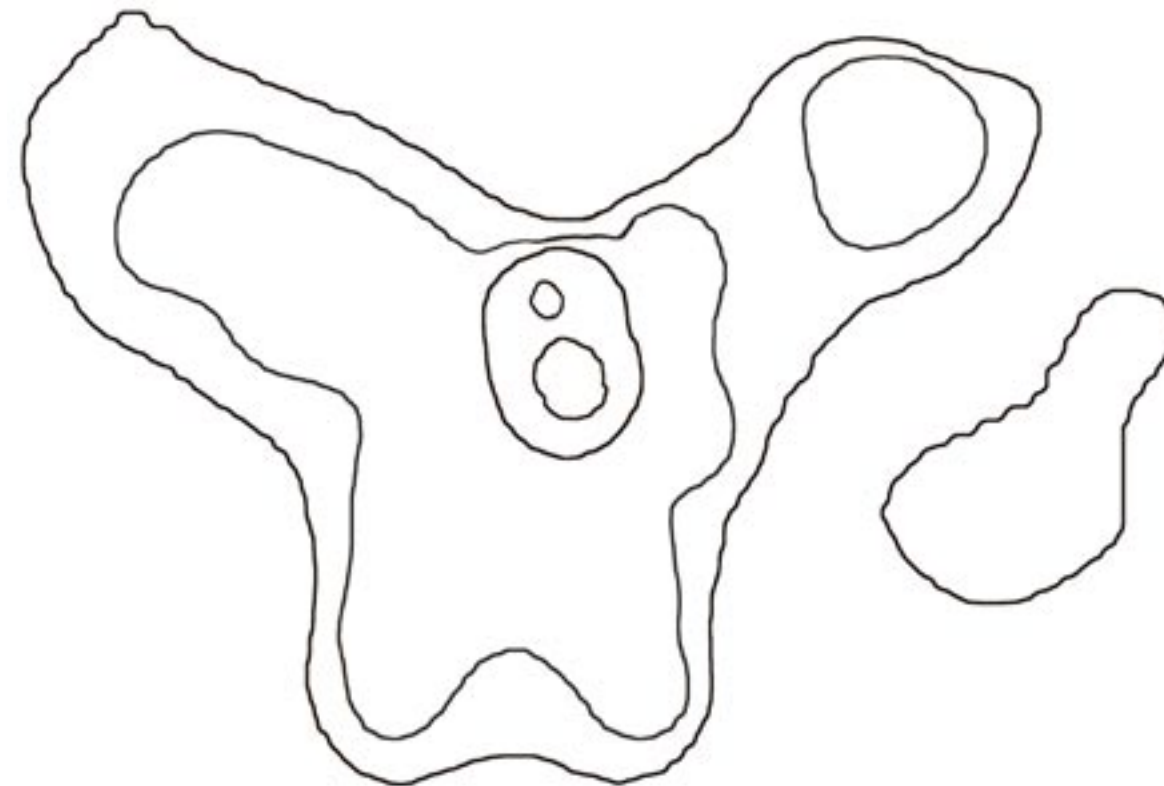

The butterfly-shaped galaxy NGC 6240 is a good example of a "starburst" galaxy. It was formed from a relatively recent (30 million years ago) merger of two smaller galaxies. The merger is causing stars to form, evolve, and explode at an exceptionally rapid rate, creating the large cloud of multi-million degree Celsius gas seen in this image.

The central region of the merged galaxy contains an extraordinary feature: there are two bright nuclei. Chandra was able to clearly distinguish the two nuclei, and to measure the details of the X-radiation from each, revealing features that are characteristic of active supermassive black holes.

Over the course of the next few hundred million years, the two supermassive black holes, which are now about 3000 light years apart, will drift toward one another and merge to form one larger, even more supermassive black hole. This catastrophic event will unleash intense radiation and gravitational waves. Future NASA satellites such as LISA will try to catch the gravitational waves in the aftermath of a merger.



CHANDRA X-RAY OBSERVATORY

Spacey Maze

Start

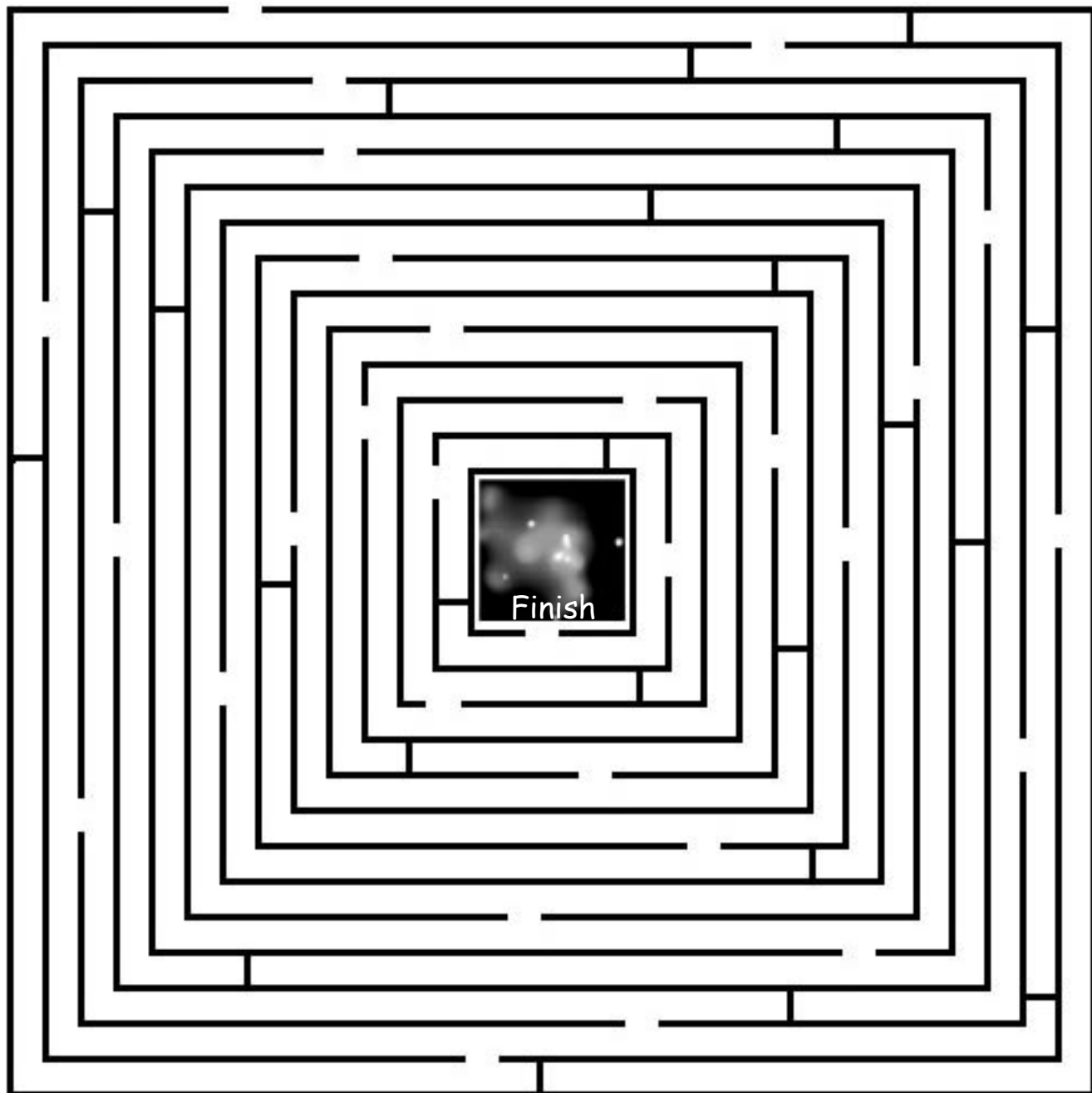

The white dot in the center of the Chandra image is a candidate for the supermassive black hole at the center of our Milky Way galaxy. This source is called Sagittarius A*. Follow the maze and take a trip to our galactic center.



CHANDRA X-RAY OBSERVATORY

Breaking the Code!

8								
7	U	K		Z		J		V
6	A			E			I	
5		O			Y	S		
4	W			C		T		H
3		G	R		F		P	
2	N					B		
1		D		L			M	
0					Q			X
	1	2	3	4	5	6	7	8

Answer the questions, using the locations in the grid above to put them in code.
Example: Science = (6,5) (4,4) (7,6) (4,6) (1,2) (4,4) (4,6)

1. What is your name in code?
2. This X-ray observatory is named after a famous astrophysicist.
3. We call ours the Milky Way.
4. This was the 1st Space Shuttle commanded by a woman, mission STS-93.
5. The study of the stars.
6. Chandra detects these to observe space.
7. When a star explodes it is called this.
8. Nothing can escape the pull of this object, not even light.
9. The US government organization that directs space missions.
10. A ball of gas, such as our Sun.



CHANDRA X-RAY OBSERVATORY

Galaxy Clusters: 3C295



Galaxy cluster 3C295 is one of the most distant clusters observed by X-ray telescopes. It is 4.6 billion light years away. The light we are seeing has travelled for almost 5 billion years. The cluster has a diameter of more than 2 million light years, and the space between the galaxies is filled with a cloud of 50 million degree gas that radiates strongly in X-rays. X-rays from the explosive central galaxy are concentrated in three bright knots that form a line. The center knot coincides with the center of the galaxy and is probably associated with a supermassive black hole.



CHANDRA X-RAY OBSERVATORY

Galaxy Clusters: Hydra A

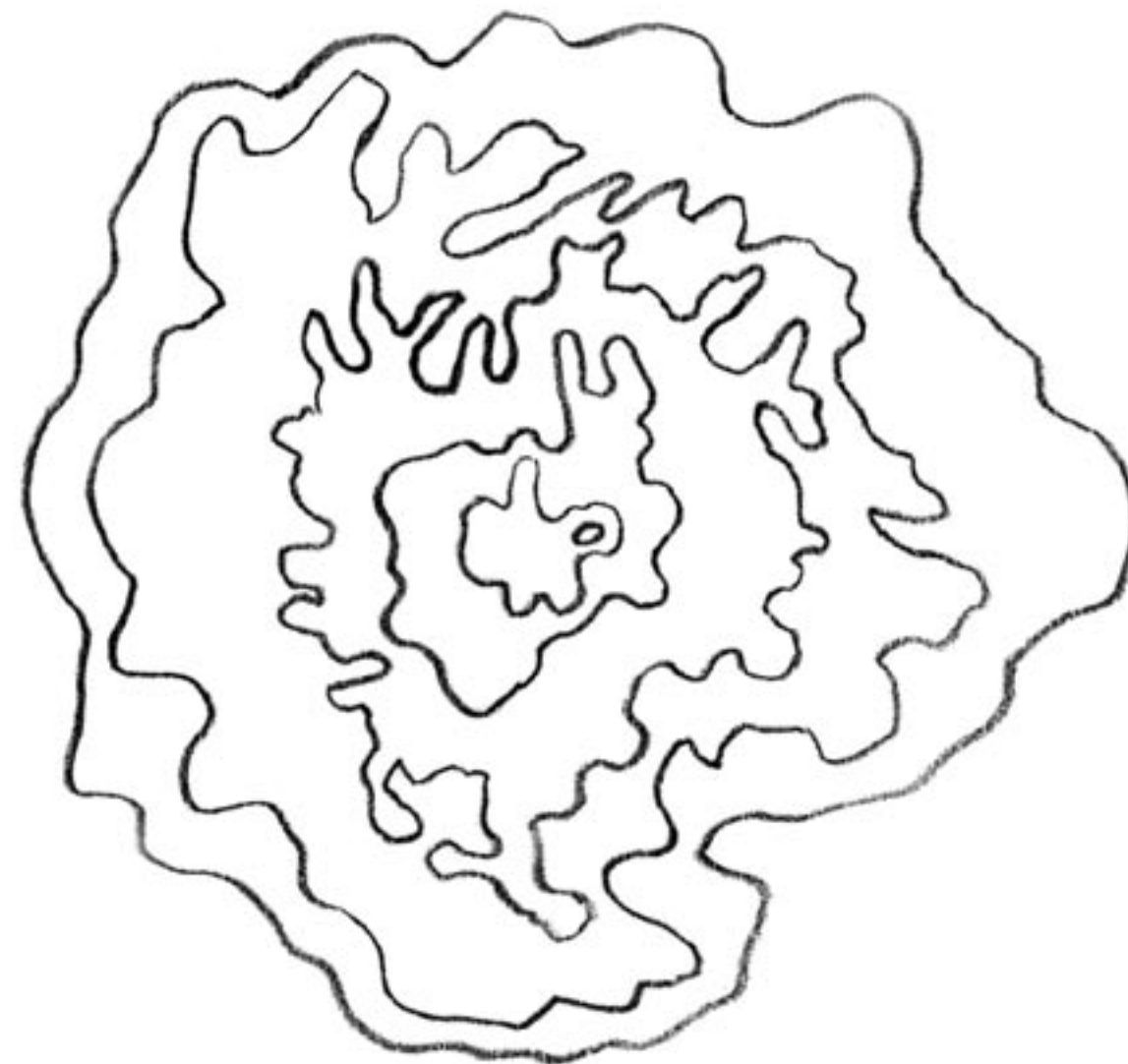

Galaxies can swarm together to form groups and clusters of galaxies. X-ray observations show that these enormous systems of galaxies are filled with giant clouds of hot gas. The galaxy cluster Hydra A is 840 million light years from Earth. The Chandra image shows long strands of hot gas extending away from the center of the cluster. A supermassive black hole at the core of the central galaxy may be causing explosions and magnetic fields that are pushing the strands away.



CHANDRA X-RAY OBSERVATORY

Mystery: Eta Carinae



Eta Carinae is a very unusual, unstable star. It is the most luminous star known in our galaxy, radiating energy at a rate 5 million times that of our sun. Its mass has been estimated at 120 times the mass of our sun, making it a candidate for the most massive known star in our galaxy. The Chandra observation shows three distinct structures: an outer, horseshoe-shaped ring associated with a shock wave from matter blown away from the star about 2000 years ago, a hot inner core associated with an intense optical brightening seen about 150 years ago, and within that core, a central source which may contain the superstar itself. Some astronomers think that it could explode as a supernova at any time, and they are watching it closely! At a distance of 7,000 light years from Earth, this gigantic explosion would pose no threat to life but it would be quite a show.



CHANDRA X-RAY OBSERVATORY

Word Jumble

A **(R)** C A N D H

T A L L C O I N E S T N O

Y A X **(R)**

P E C A S

S N A **(A)**

B R I **(T)** O

L C **(O)** R O

(V) U E R S N A P O

T R A **(S)**

E K A L L H **(B)** C O

H L T I G

X L G A A Y

C I E S **(E)** N C

I R M **(O)** R S R

K A L M I Y W **(Y)**

New Word: _____

Unscramble the letters to form a word or phrase. Then use the circled letters to form a new word. See the last page for answers.



CHANDRA X-RAY OBSERVATORY

What's Next? Constellation-X!



NASA has started a new program of space science missions called "Beyond Einstein", to be launched starting around 2012. The Beyond Einstein missions will be designed to study some of the most difficult, still unanswered questions raised by Einstein's theory of relativity: What powered the "Big Bang"? What happens at the edge of a black hole? What is dark energy?. The X-ray mission in this program is called Constellation-X.

Constellation-X is a set of X-ray telescopes (probably 4) that will orbit close to each other in space. The telescopes will work together to observe the same distant objects at the same time. The combined data-gathering ability from this group of X-ray telescopes will be 100 times more powerful than any single X-ray telescope that has come before.



CHANDRA X-RAY OBSERVATORY

What's Next? Constellation-X!

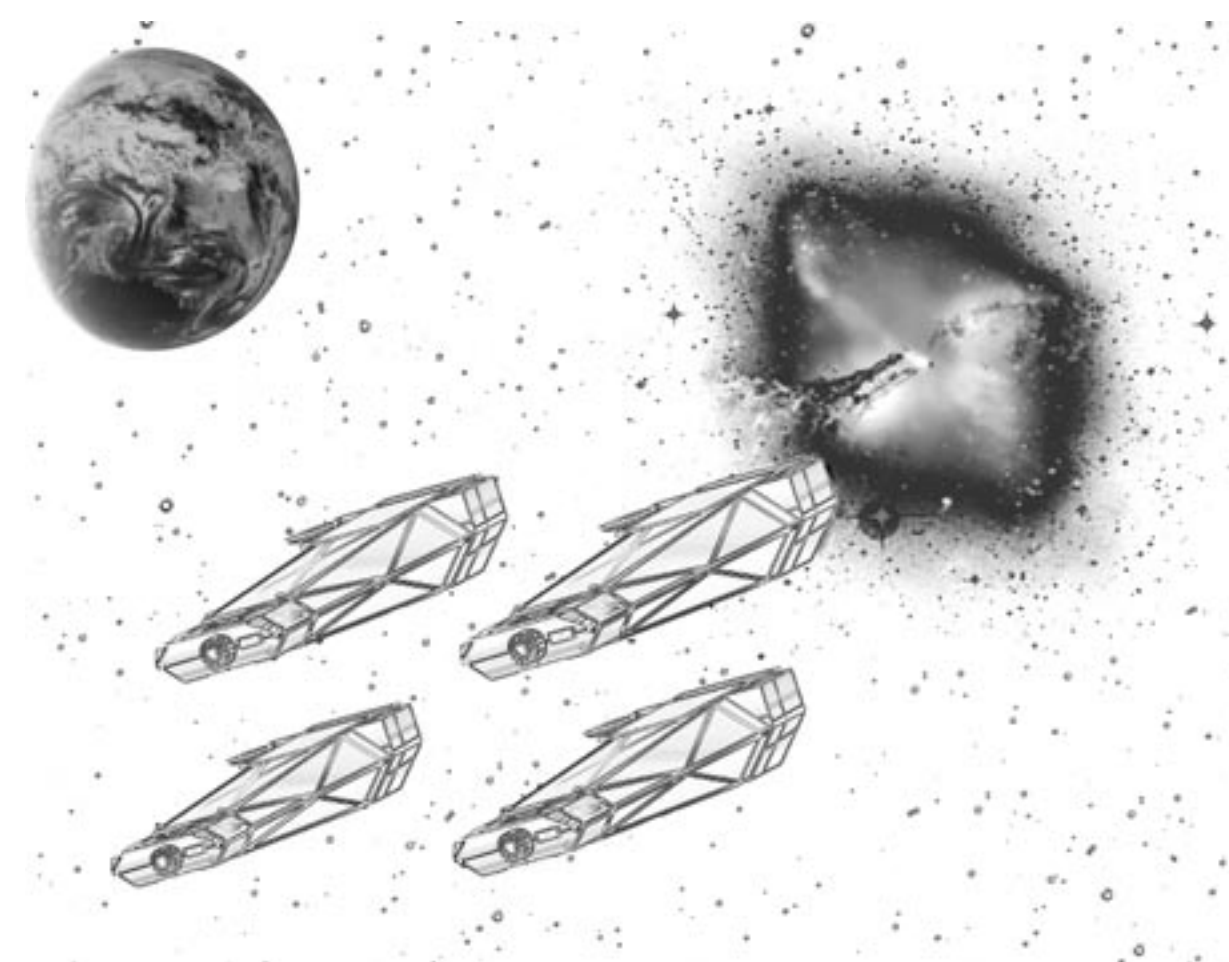

With the power of Constellation-X, scientists will be able to explore some of the great remaining mysteries about the origin and evolution of our Universe. To read more about Constellation-X visit the program web site at <http://constellation.gsfc.nasa.gov/>.

Puzzler: Why was this mission named "Constellation-X"?
(hint: look up the meanings of the word "constellation" in a dictionary)



CHANDRA X-RAY OBSERVATORY

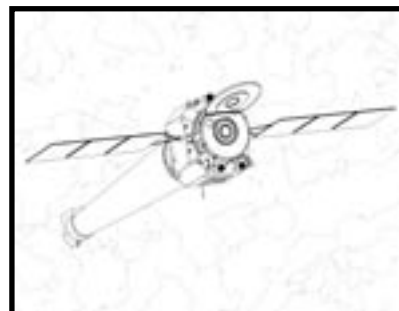

Organizations with major involvement in the Chandra project:

Overall Program Management: NASA Marshall Space Flight Center

Prime Contractor: TRW (now NGST) - Spacecraft Construction and Integration

Major Subcontractors:

- Raytheon Optical Systems - Mirror Grinding and Polishing
- Optical Coating Laboratories, Inc. - Mirror Coating and Cleaning
- Eastman Kodak Corporation - Mirror Assembly
- Ball Aerospace and Technology Corp. - Science Instrument Module & Aspect System

Science Instruments:

- Advanced CCD Imaging Spectrometer (ACIS) - Penn State University and Massachusetts Institute of Technology (MIT)
- High Resolution Camera (HRC) - Smithsonian Astrophysical Observatory (SAO)
- High Energy Transmission Grating - MIT
- Low Energy Transmission Grating - Space Research Institute Netherlands and Max Planck Institute in Germany

Telescope Scientist: Dr. Leon VanSpeybroeck, SAO

Mission Support Team: SAO

Chandra X-ray Center: SAO (with MIT & NGST personnel)



Jumble Answers:

Chandra	NASA	Star	Science
Constellation	Orbit	Black hole	Mirrors
X-ray	Color	Light	Milky Way
Space	Supernova	Galaxy	Observatory (new word)

Crossword Answers:

ACROSS	DOWN
3. Visible	1. Collins
6. Supernova	2. Columbia
7. Cluster	4. Spectrum
8. Star	5. Xrays
10. Millions	9. Milky Way

Code Answers:

- Chandra - (4,4) (8,4) (1,6) (1,2) (2,1) (3,3) (1,6)
- Galaxy - (2,3) (1,6) (4,1) (1,6) (8,0) (5,5)
- Columbia - (4,4) (2,5) (4,1) (1,7) (7,1) (6,2) (7,6) (1,6)
- Astronomy - (1,6) (6,5) (6,4) (3,3) (2,5) (1,2) (2,5) (7,1) (5,5)
- X-rays - (8,0) (3,3) (1,6) (5,5) (6,5)
- Supernova - (6,5) (1,7) (7,3) (4,6) (3,3) (1,2) (2,5) (8,7) (1,6)
- Black Hole - (6,2) (4,1) (1,6) (4,4) (2,7) (8,4) (2,5) (4,1) (4,6)
- NASA - (1,2) (1,6) (6,5) (1,6)
- Star - (6,5) (6,4) (1,6) (3,3)

NASA's CHANDRA X-RAY OBSERVATORY COLORING & ACTIVITY BOOK



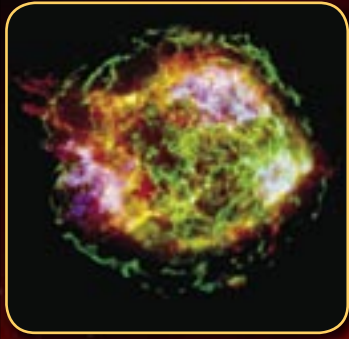

Cassiopeia A



3C295



NGC 6240



Centaurus A

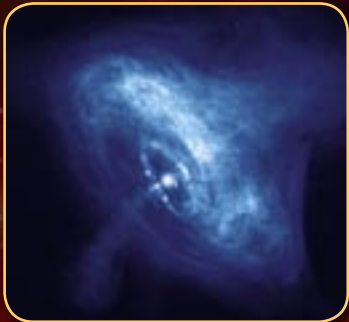

Crab Nebula



Eta Carinae



E0102



Hydra A